

Vogt Tube - Ice machines P24FL

In 1938, Vogt Ice revolutionized the ice making industry by introducing the world's first automatic sized icemaker. Today, Vogt Tube-Ice machines enjoy a well-earned reputation as the most energy efficient, dependable ice machines on the market.

Heavy-duty industrial construction, automatic operation, and the best warranty in the business make the Vogt ice machines the only "clear" choice for your ice making needs.

Three Ice Sizes Available:

- Cylinder (Tube-Ice)
 - 7/8" Diameter X 1" long
 - 1 1/8" Diameter X 1" long
 - 1 3/8" Diameter X 1" long

P24FL Features:

- 25 Year Life expectancy
- Up to 25 tons per day
- 25 Year evaporator warranty
- Stainless Steel Water Pump with TEFC Motor
- Manufactured in accordance with the A.S.M.E. code
- R404a Refrigerant
- Controls U.L. Approved
- Factory Tested and Certified
- High Energy Efficiency

Options:

- All Stainless Steel Construction
- PLC Controls
- Crushed Ice



Vogt® Tube-Ice Machines

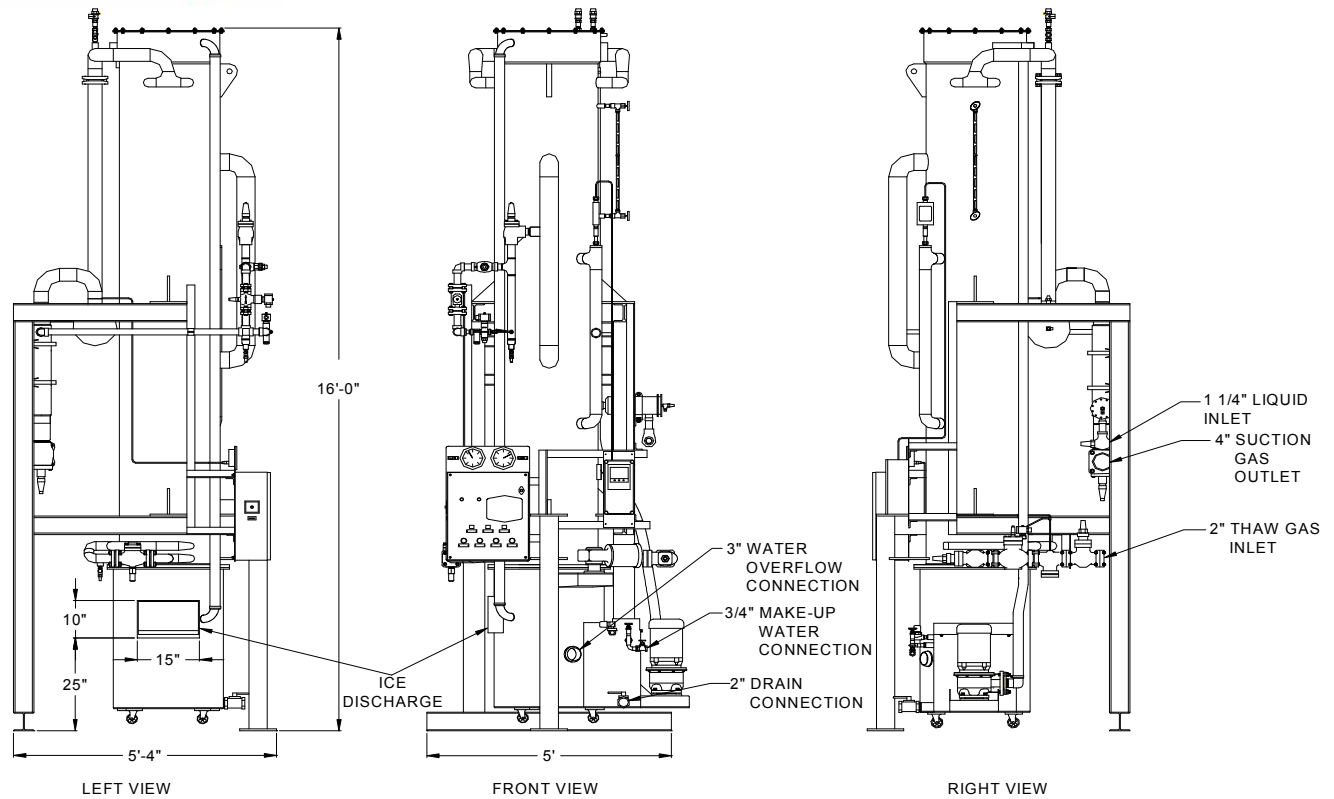

SPECIFICATIONS												
MODEL P24FL (R-404a Refrigerant)												
STANDARD CAPACITY, TONS PER 24 HOURS												
WATER TEMP.	7/8" DIA. ICE			1 1/8" DIA. ICE			1 3/8" DIA. ICE					
80 °F	21.0			22.5			20.2					
70 °F	22.1			23.7			21.3					
60 °F	23.3			25.1			22.6					
50 °F	24.7			26.6			24.0					
WEIGHT (LBS)	OPERATING: 6,260 SHIPPING: 5,400			OPERATING: 5,860 SHIPPING: 5,000			OPERATING: 5,860 SHIPPING: 5,000					
STANDARD ELECTRICAL	230 V, 3P, 60 Hz - 460V, 3P, 60 Hz - 400V, 3P, 50 Hz (OPTIONAL ELECTRICAL ARRANGEMENTS ON REQUEST)											
CAPACITY TABLE, TONS PER 24 HOURS (AT SUCTION TEMPERATURE °F)												
WATER TEMPERATURE	0			5			15			20		
	7/8"	1 1/8"	1 3/8"	7/8"	1 1/8"	1 3/8"	7/8"	1 1/8"	1 3/8"	7/8"	1 1/8"	1 3/8"
80 °F	26.9	29.4	26.5	24.5	26.5	23.9	17.1	18.2	16.3	12.9	13.6	12.2
70 °F	28.2	30.9	27.8	25.7	27.9	25.2	18.1	19.2	17.2	13.7	14.4	12.9
60 °F	29.7	32.6	29.4	27.1	29.5	26.6	19.2	20.3	18.3	14.6	15.3	13.7
50 °F	31.4	34.4	31.1	28.7	31.2	28.2	20.4	21.6	19.5	15.5	16.3	14.6
NOTE: STANDARD CAPACITY BASED ON SUCTION TEMPERATURE OF 10 °F AND AN AMBIENT (AIR) TEMPERATURE OF 90 °F												

Vogt reserves the right to change designs and specifications without notice.

Operating Conditions:

The ice machine shall not be subjected to an atmospheric temperature lower than 50 °F nor higher than 90 °F without effect on performance. Water for condensing and for ice making purposes shall be non-corrosive.

The water shall be at a constant pressure not less than 30 lbs. at the ice machine location. The condition of the water to make satisfactory ice shall be the responsibility of the purchaser.



Vogt Ice, LLC
 1000 West Ormsby Ave.,
 Louisville KY 40210
 Phone: 502-635-3000
 E-mail: info@vogtice.com

